



# CROWN<sup>®</sup> PIPES

PUTTING SAFETY AND QUALITY FIRST

# ENDURO

SANITARY GRAY PIPES

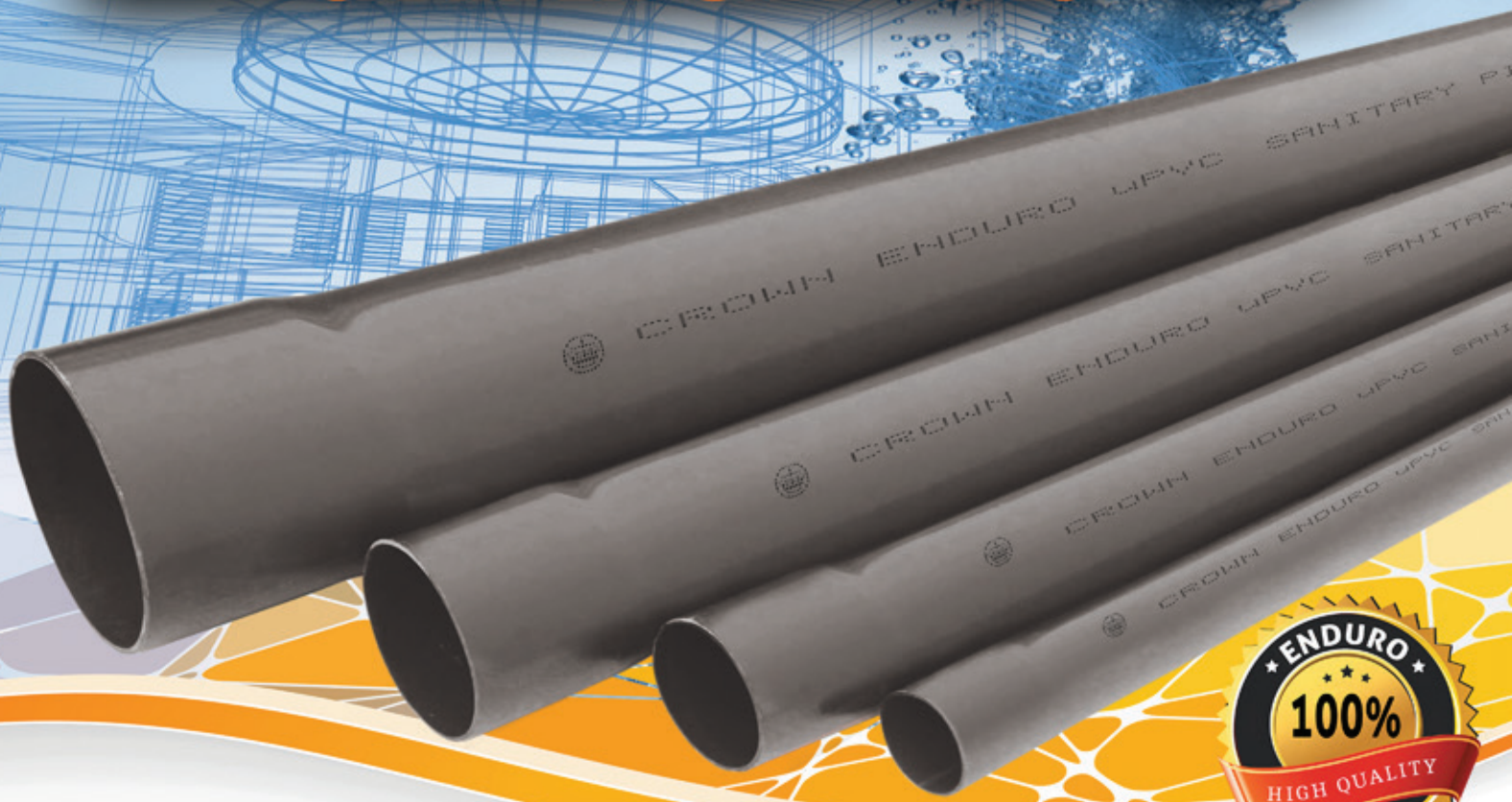

## ENDURO SANITARY GRAY PIPES

	NOMINAL SIZE	THICKNESS
2"	63mm x 3meters	1.85
3"	90mm x 3meters	2.54
4"	110mm x 3meters	2.54
6"	160mm x 3meters	3.90





Disc.

# ENDURO-GRAY SANITARY FITTINGS

PIPE COVER 	NOMINAL SIZE		PRICE
	2"	63 mm	5.00 / pc.
	3"	90 mm	10.00 / pc.
	4"	110 mm	15.00 / pc.

ELBOW 90° 	NOMINAL SIZE		PRICE
	2"	63 mm	11.00 / pc.
	3"	90 mm	32.00 / pc.
	4"	110 mm	43.00 / pc.
	6"	160 mm	310.00 / pc.
8"	200 mm	705.00 / pc.	

ELBOW 45° 	NOMINAL SIZE		PRICE
	2"	63 mm	9.00 / pc.
	3"	90 mm	17.00 / pc.
	4"	110 mm	38.00 / pc.
	6"	160 mm	204.00 / pc.
8"	200 mm	555.00 / pc.	

CLEAN OUT W/ O-RING 	NOMINAL SIZE		PRICE
	2"	63 mm	10.00 / pc.
	3"	90 mm	20.00 / pc.
	4"	110 mm	32.00 / pc.
6"	160 mm	205.00 / pc.	

COUPLING 	NOMINAL SIZE		PRICE
	2"	63 mm	7.50 / pc.
	3"	90 mm	15.00 / pc.
	4"	110 mm	25.72 / pc.
6"	160 mm	205.00 / pc.	

Disc. \_\_\_\_\_

U-TRAP 	NOMINAL SIZE		PRICE
	2"	63 mm	40.00 / pc.
	3"	90 mm	100.00 / pc.
4"	110 mm	135.00 / pc.	

P-TRAP W/ ELBOW 45°(SET) 	NOMINAL SIZE		PRICE
	2"	63 mm	49.00 / pc.
	3"	90 mm	117.00 / pc.
	4"	110 mm	173.00 / pc.

BUSHING REDUCER 	NOMINAL SIZE		PRICE
	3" x 2"	90 x 63 mm	15.00 / pc.
	4" x 2"	110 x 63 mm	25.00 / pc.
	4" x 3"	110 x 90 mm	30.00 / pc.
	6" x 2"	160 x 63 mm	93.00 / pc.
	6" x 3"	160 x 90 mm	190.00 / pc.
	6" x 4"	160 x 110 mm	190.00 / pc.
	8" x 2"	200 x 63 mm	255.00 / pc.
	8" x 3"	200 x 90 mm	260.00 / pc.
8" x 4"	200 x 110 mm	280.00 / pc.	
8" x 6"	200 x 160 mm	320.00 / pc.	

WYE 	NOMINAL SIZE		PRICE
	2" x 2"	63 x 63 mm	17.50 / pc.
	3" x 2"	90 x 63 mm	33.00 / pc.
	3" x 3"	90 x 90 mm	41.00 / pc.
	4" x 2"	110 x 63 mm	48.00 / pc.
	4" x 3"	110 x 90 mm	58.00 / pc.
	4" x 4"	110 x 110 mm	74.00 / pc.
	6" x 4"	160 x 110 mm	380.00 / pc.
	6" x 6"	160 x 160 mm	477.00 / pc.
8" x 8"	200 x 200 mm	1,058.00 / pc.	

TEE 	NOMINAL SIZE		PRICE
	2" x 2"	63 x 63 mm	16.50 / pc.
	3" x 2"	90 x 63 mm	32.00 / pc.
	3" x 3"	90 x 90 mm	40.00 / pc.
	4" x 2"	110 x 63 mm	45.00 / pc.
	4" x 3"	110 x 90 mm	56.00 / pc.
	4" x 4"	110 x 110 mm	68.00 / pc.
	6" x 4"	160 x 110 mm	325.00 / pc.
	6" x 6"	160 x 160 mm	385.00 / pc.
8" x 8"	200 x 200 mm	832.00 / pc.	

Disc. \_\_\_\_\_

## CROWN SOLVENT CEMENT

PRODUCT	PRICE
Crown Solvent Cement 100cc	75.00 / can
Crown Solvent Cement 200cc	110.00 / can
Crown Solvent Cement 400cc	185.00 / can



A QUALITY PRODUCT MANUFACTURED BY:

**CROWN ASIA CHEMICALS CORPORATION**

OFFICE: Rm. 508 President Tower, 81 Timog Avenue, Quezon City • Tel No.: 8294-2071 • Fax No.: 3412-0642

PLANT / OFFICE: ITC Compound, Canumay East Valenzuela City, Metro Manila • Tel No. : 8277-0880

PLANT: Km. 33 McArthur Highway, Tuktukan, Guiguinto Bulacan, Philippines

Email: sales@crownpvc.com.ph • Website: www.crownpvc.com.ph